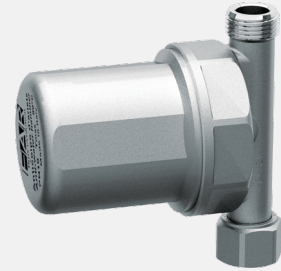

ART.2895

**Water hammer arrester for sanitary systems**

- Body in CW617N brass
- 1/2" Male connection
- EPDM sealing gasket
- Maximum pressure: 50bar
- Nominal pressure: 10bar
- Maximum working temperature: 90°C

ART.2896

**Water hammer arrester for under-basin or washing machine installation**

- Body in CW617N brass
- 3/8" - 3/4" male connection and female swiveling nut
- EPDM sealing gasket
- Maximum pressure: 50bar
- Nominal pressure: 10bar
- Maximum working temperature: 90°C

## 1 DESCRIPTION

The phenomenon of water hammer occurs inside pipelines when a device (such as a tap or a mixer, etc.) is suddenly opened or closed, creating harmful overpressures inside the system.

Once generated, the wave of overpressure adds to the existing pressure in the pipes and stabilizes at values higher than the initial ones.

FAR water hammer arrester mitigates the effect of such overpressures, thus ensuring the proper functioning of the components located in the system. It will also considerably reduce the noise generated by vibration that occurs due to the sudden closure of the interceptions.

## 2 CONSTRUCTION FEATURES

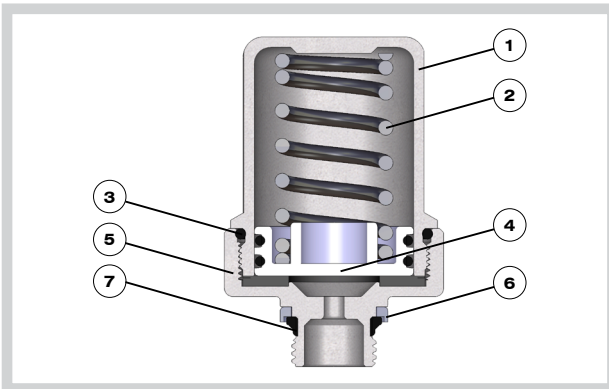

1- UPPER BODY	CW617N BRASS
2- SPRING	AISI302
3- O-RING	EPDM
4- DISC	PLASTIC MATERIAL
5- LOWER BODY	OTTONE CW617N
6- RING	CW614N
7- GASKET	EPDM

## 3 WORKING PRINCIPLE

The overpressures are attenuated by an air chamber and a steel spring that is connected to a plastic disc with a double O-ring seal, thus opposing the force of the fluid and absorbing much of the excess pressure.

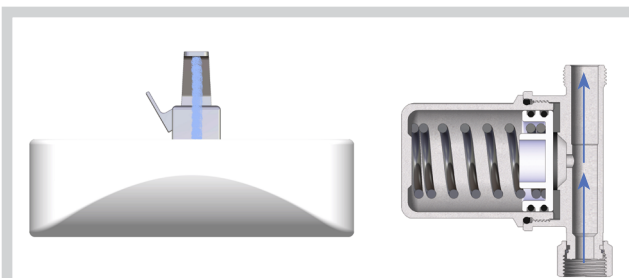
**OPEN USER**

In this condition the pressure remains constant along the entire pipeline.

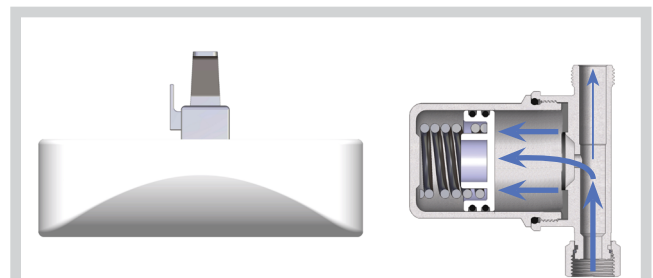
**CLOSED USER**

In this condition the pressure increases along the pipeline and the water hammer arrester absorbs the excess pressure, thus preserving the components.

## 4 INSTALLATION

It is recommended that the water hammer arrester is installed directly on the circuit of the individual users (ball valves, sanitary fittings, electric valves, etc.) or positioned on the distribution manifold.

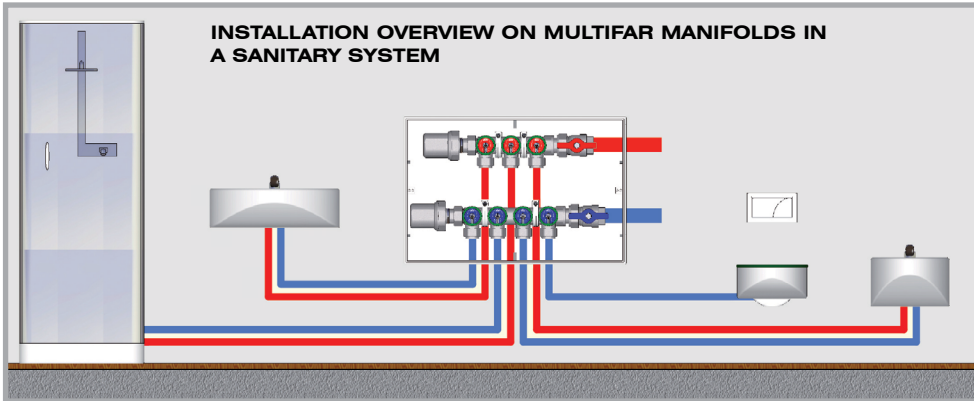

The water hammer arrester can be installed in vertical, horizontal or upside down position.

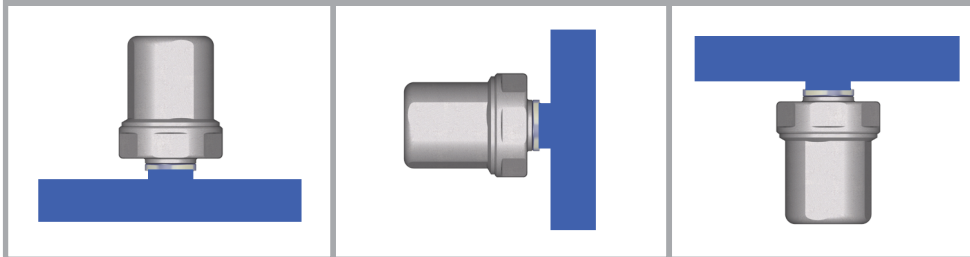

In locating the water hammer correct position in a system, it is important to avoid creating areas where stagnant water may remain, i.e. situations where bacterial colonies can proliferate. For instance, installations at the top of a riser column can create areas with still water ("dead zones"), even though the water hammer arrester will function properly. Consequently, this kind of installation must be avoided.

## 5 TECHNICAL FEATURES

Nominal pressure: 10bar  
 Maximum pressure: 50bar  
 Maximum working temperature: 90°C

## 6 DIMENSIONAL FEATURES

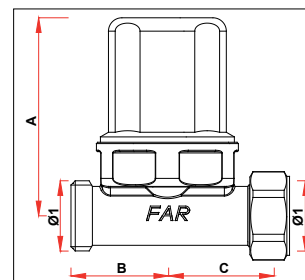

CODE	Ø1	A	B	C
2896 38	G3/8	70	37	37
2896 34	G3/4	74	36	40

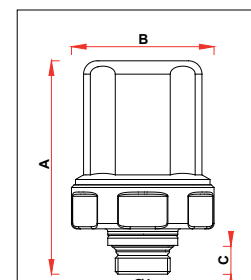

CODE	Ø1	A	B	C
2895 12	G1/2	80	53	11